

Royal Exclusiv pumps & skimmers

Klaus Jansen // Richard-Byrd-Str.7 // 50829 Cologne // Germany

Fon +49(0)221/222886 0 // Fax +49(0)221/22288622

info@royal-exclusiv.de // www.royal-exclusiv.de



Since 1986



Data sheet and list of spare parts for Bubble King® DeLuxe 300
For all Bubble King® DeLuxe protein skimmer 300 external

vs12

ENG





Data sheet for protein skimmer Bubble King® DeLuxe 300 external

Protein skimmer Bubble King® DeLuxe 300 external Product no.: 80 **1.808,00 €**
for aquariums from 1.200 ltr. up to 3.000 ltr.

*Skimmer-series Bubble King® DeLuxe for aquarium-grounds.
For external installation outside of filter-systems. For the demanding user.*

Technical data Bubble King® DeLuxe 300:

2.000 ltr./h Air - 4.000 ltr./h Water = 1 pump Bubble King® 2000
with AKB- (anti-lime-bypass) for external use
Baseplate: 33 cm x 51 cm / height ~ 77 cm

Skimmer-pump: Bubble King® 2000 with AKB (anti-lime-bypass)
Delivery rate: 2.000 l/h Air inlet ~ 4.000 l/h Water inlet
Wattage - active power: P = 58 Watt/h
Operating voltage: 230 Volt 50 Hz (also in 110V/60Hz available)
Protection class: IP 68
Connecting tube: 25 mm
Required performance of the drivers pump: 500 - 2.000 l/h
Weight skimmer: 16 kg inclusiv pump

Dimension skimmer with pump (stands on PVC body):
325 mm wide / 505 mm length / ~ 770 mm height
Height silicon outlet (cleanout) ~ 580 mm

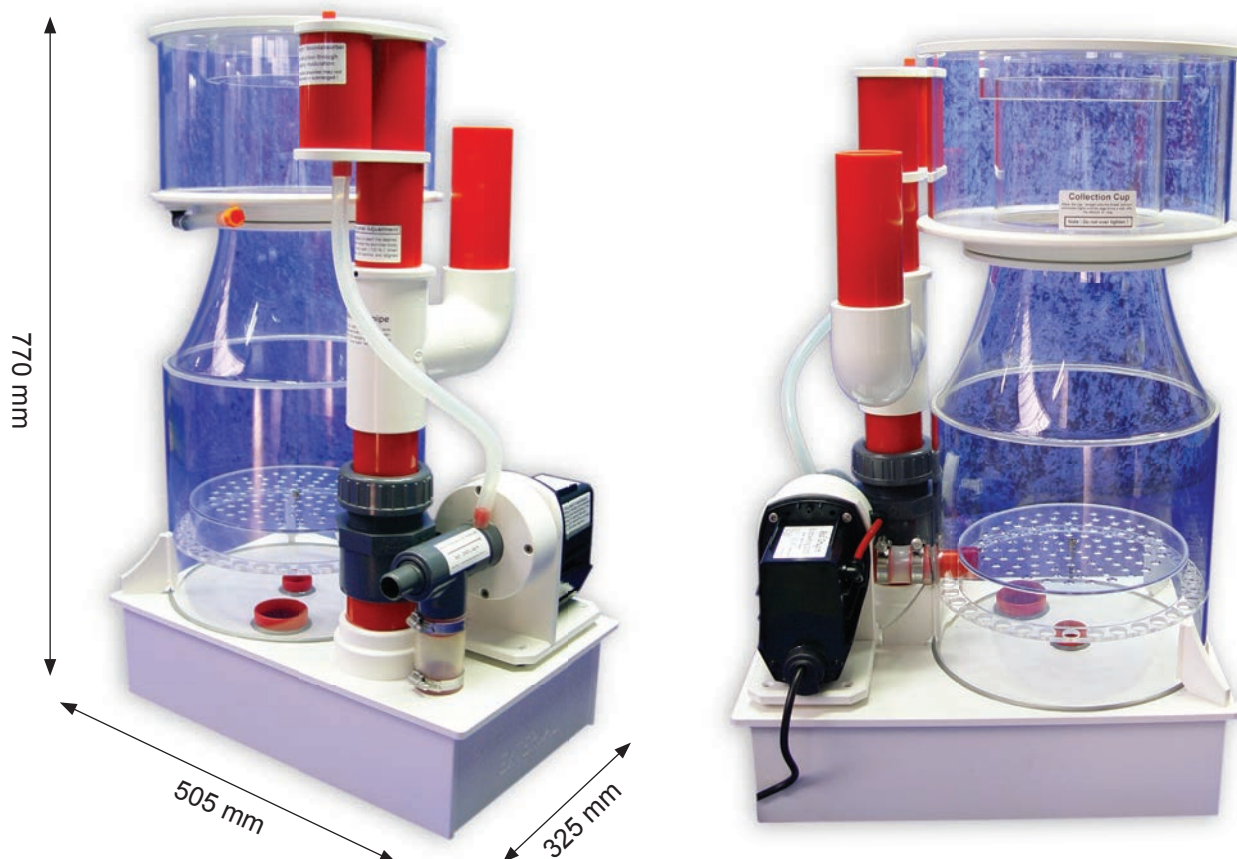
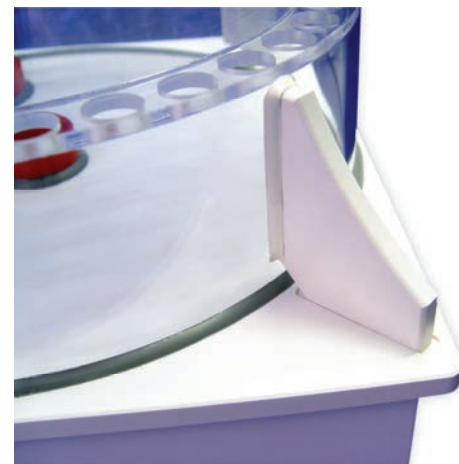

For more information, please visit www.royal-exclusiv.de. Simply enter the part number or name into the search box or email: info@royal-exclusiv.de.

All information subject to change. We try our best, but printing errors reserved.

Protein skimmer Bubble King® DeLuxe 300 extern Product no.: 80

Protein skimmer Bubble King® DeLuxe 300 for external filter assembly in aquariums of 1.200 l to 3.000 l.

The skimmer is equipped with a Red Dragon® Bubble King® skimmer pump from Royal Exclusiv®, installed on the side. The complete piping technique is housed in the white PVC sub-structure.

A continuously height-adjustable telescopic tube is intended for water level regulation. The side vertical swivelling water outlet has a tube diameter of 63 mm. For the fine adjustment of the water level, there is also a 360° pivotable PVC torque tube with a fitted dismountable simple silencer.

The perforated Plexiglas lid can be opened by loosening the M6 titanium hexagon socket screw in the centre.

The complete skimmer cup can be unscrewed from the pillar tube. The lift height required for this is 30 mm. A pivotable tap is fitted to the bottom for draining off the absorbate.

The skimmer pump is equipped with a descaling bypass. The connection of skimmer and pump is done, suction- and pressure-side with silicone hoses. This silicone hose connections are with V4A broadband clamps (hose band clips) secured. The 9 mm silicone tube connects the air intake between pump and resonator.

For the operation of the skimmer an additional driver pump is to connect, which supplies the foamer with the water to be filtered. The sockets provided for this purpose has a diameter of 25 mm. The required performance of the drivers pump is located between 500 – 2.000 l/h.

Important maintenance information!!!

For the smooth functioning of the protein skimmer, the skimmer pump must be regularly cleaned and decalcified!

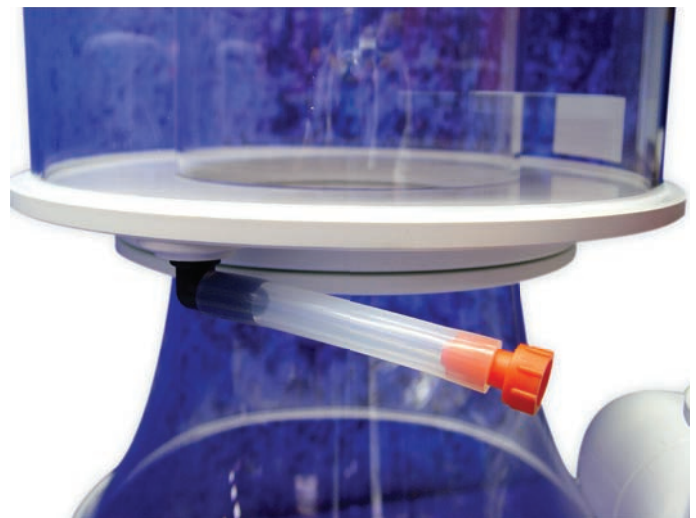



Protein skimmer Bubble King® DeLuxe 300 extern **Product no.: 80**

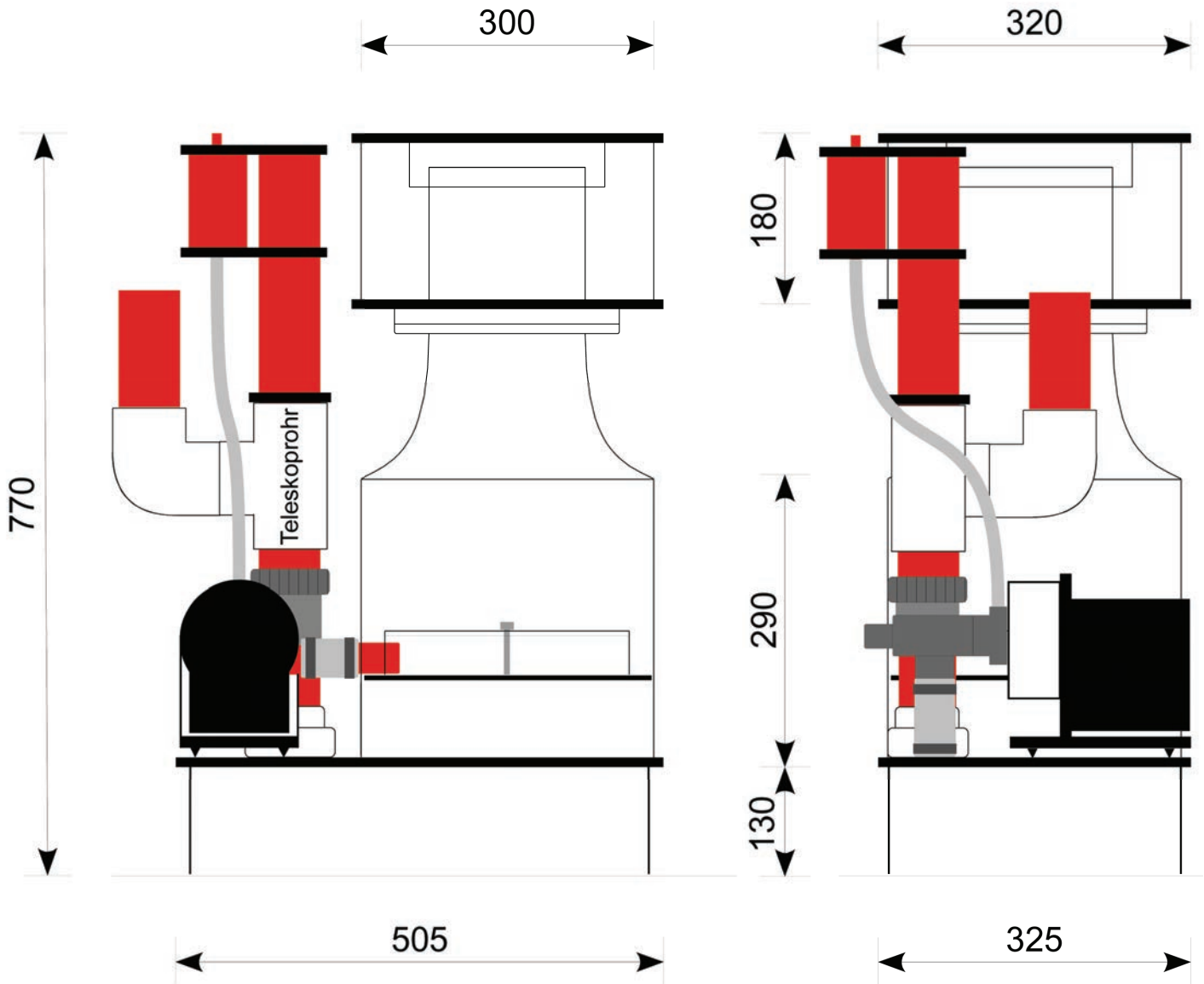



Since 1986

**Protein skimmer Bubble King® DeLuxe 300 extern** **Product no.: 80**











<i>list of spare parts</i>	<i>product no. (110V)</i>	<i>(230V)</i>	<i>Price</i>
resonator single for Ø 63mm torque tube	293	293	49,00 €
silicon-outlet (cleanout)	298	298	22,40 €
lid complete with lever ring	314	314	105,50 €
cup with conus / stand pipe / cleanout	358	358	352,00 €
silicon O-ring 180x3,0mm for conus	334	334	8,70 €
silicon hose - Ø 30mm 50mm length	296-1	296-1	8,00 €
silicon hose - Ø 40mm 60mm length	296-2	296-2	9,00 €
V4A stainless hose band clip 25-40mm	197	197	7,80 €
V4A stainless hose band clip 32-50mm	198	198	9,60 €
torque tube Ø 63mm PVC red	347	347	47,00 €
titan screw for injection pan 6x45mm	183-5	183-5	7,70 €
silicon hose 9x3mm (price for one meter)	185	185	18,50 €
skimmer pump external BK 2000 complete	113/1-2	113/2-2	727,00 €
part motor block BK 2000 with AKB (anti-lime-bypass)	138/1-1	138/2-1	352,00 €
pump head PVC white with AKB (anti-lime-bypass)	252	252	236,20 €
rotor complete with metal shaft for BK 2000	125/1-3	125/2-3	205,00 €
carbon bearing with O-ring 1 piece	155	155	6,50 €
V4A screws for pump head 4 pieces	182	182	7,70 €
V4A screws for motor block 4 pieces 6x22mm	182-1	182-1	3,70 €
pump holder normal PVC white	148	148	95,00 €
rubber feets 4 pieces	180	180	4,00 €
V4A screw 6 x 110mm for resonator / silencer	182-4	182-4	7,00 €
AKB (anti-lime-bypass) hose Ø 8mm red	295	295	4,00 €
silicon O-ring 90x2,5mm for pump head BK2000	169	169	5,10 €
silicon O-ring 82x4,0mm for motor block BK2000	170	170	4,45 €

For the list of spare parts for Red Dragon® 3 skimmer pump see separate document.
Downloadable on our website under Red Dragon® 3 skimmer pump.

<i>accessories</i>	<i>product no. (110V)</i>	<i>(230V)</i>	<i>Price</i>
add on resonator Ø 63mm	999	999	32,00 €
PVC pipe clip Ø 63mm for wall and ceiling mounting	930-63	930-63	6,50 €
resonator - inlay	294-1	294-1	5,90 €
silicon grease tube 6g	030/6	030/6	2,50 €
silicon grease tube 25g	030/25	030/25	7,50 €

Protein skimmer Bubble King® DeLuxe 300 extern **Product no.: 80**

Please replace the **x** with the appropriate number for the voltage of 110/230 Volt.













<i>spare part</i>	<i>spare part</i>	<i>spare part</i>	<i>spare part</i>
			
resonator single for Ø 63mm torque tube 293 49,00 €	silicon-outlet (cleanout) 298 22,40 €	lid complete with lever ring 314 105,50 €	cup with conus / stand pipe cleanout 358 352,00 €
<i>spare part</i>	<i>spare part</i>	<i>spare part</i>	<i>spare part</i>
			
silicon O-ring 180x3,0mm for conus 334 8,70 €	silicon hose - Ø 30mm 50mm length 296-1 8,00 €	silicon hose - Ø 40mm 60mm length 296-2 9,00 €	V4A stainless hose band clip 25-40mm 197 7,80 €
<i>spare part</i>	<i>spare part</i>	<i>spare part</i>	<i>spare part</i>
			
V4A stainless hose band clip 32-50mm 198 9,60 €	torque tube Ø 63mm PVC 347 47,00 €	titan screw for injection pan 6x45mm 183-5 7,70 €	silicon hose 9x3mm (price for one meter) 185 18,50 €
<i>spare part</i>	<i>spare part</i>	<i>spare part</i>	<i>spare part</i>
			
V4A screw 6 x 110mm for resonator / silencer 182-4 7,00 €	skimmer pump external BK 2000 complete 113/x-2 727,00 €	part motor block BK 2000 with AKB (anti-lime-bypass) with AKB 138/x-1 352,00 €	pump head PVC white with AKB (anti-lime-bypass) 252 236,00 €

For more information, please visit www.royal-exclusiv.de. Simply enter the part number or name into the search box or email: info@royal-exclusiv.de.

All information subject to change. We try our best, but printing errors reserved.

Protein skimmer Bubble King® DeLuxe 300 extern **Product no.: 80**

Please replace the **x** with the appropriate number for the voltage of 110/230 Volt.

spare part	spare part	spare part	spare part
			
rotor complete with metal shaft for BK 2000 125/x-3 205,00 €	carbon bearing with O-ring 1 piece 155 6,50 €	V4A screws for pump head 4 pieces 182 7,70 €	V4A screws for motor block 4 pieces 6x22mm 182-1 3,70 €
spare part	spare part	spare part	spare part
			
pump holder normal PVC white 148 95,00 €	rubber feet 4 pieces 180 4,00 €	AKB (anti-lime-bypass) hose Ø 8mm red 295 4,00 €	silicon O-ring 90x2,5mm for pump head BK2000 169 5,10 €
spare part			
			
silicon O-ring 82x4,0mm for motor block BK2000 170 4,45 €			
accessories	accessories	accessories	accessories
			
add on resonator Ø 63mm 999 32,00 €	PVC pipe clip Ø 63mm for wall and ceiling mounting 930-63 6,50 €	resonator - inlay 294-1 5,90 €	silicon grease tube 6g 030-6 2,50 €

For more information, please visit www.royal-exclusiv.de. Simply enter the part number or name into the search box or email: info@royal-exclusiv.de.

All information subject to change. We try our best, but printing errors reserved.



Protein skimmer Bubble King® DeLuxe 300 extern **Product no.: 80**

Please replace the **x** with the appropriate number for the voltage of 110/230 Volt.

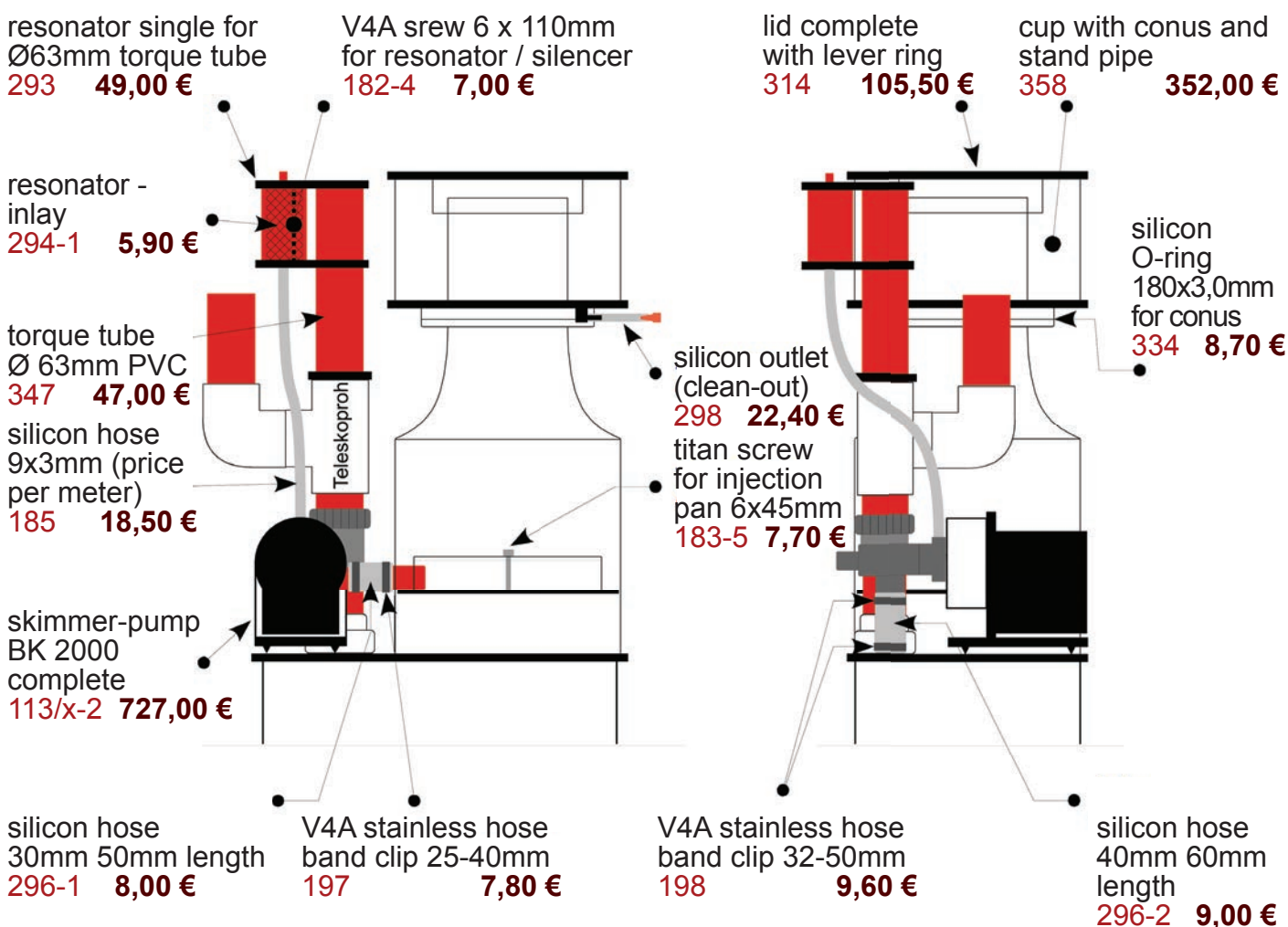



Protein skimmer Bubble King® DeLuxe 300 extern **Product no.: 80**

Please replace the **x** with the appropriate number for the voltage of 110/230 Volt.

